

Totally Bralco

BRALCO
YOUR SMART ITALIAN OFFICE

totally Bralco

1

lux
pag. 4-7

2

concerto
pag. 8-11

3

glt
pag. 12-15

4

take-off evolution
pag. 16-19

5

3° livello
pag. 20-23

6

kubick
pag. 24-27

7

winglet
pag. 28-31

8

domomag
pag. 32-35

9

rail
pag. 36-39

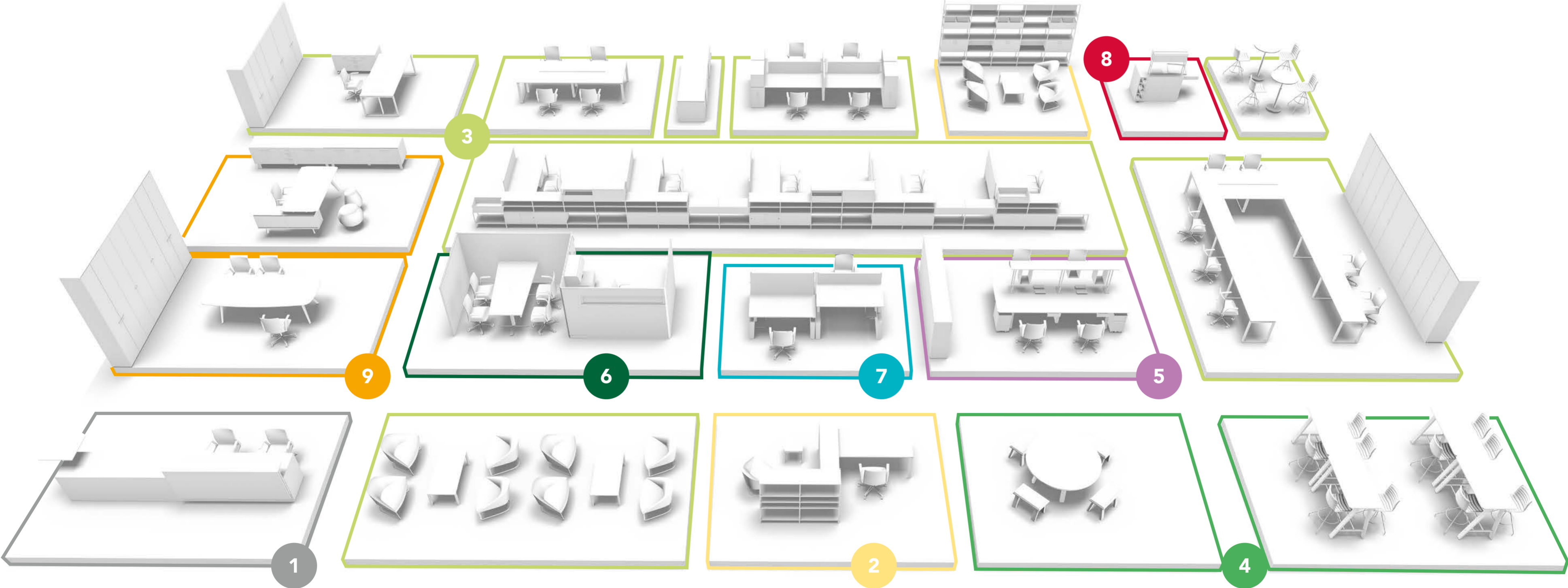

lux

Reception minimalist



Luce e minimalismo per un'elegante accoglienza.

Light and refined for an elegant welcome.
Lumière et minimalisme pour un accueil élégant.

Edler Empfang dank Licht und Minimalismus.
Luz y minimalismo para una recepción elegante.
Licht en verfijnd voor een aangenaam ontvangst.

Modularity & materials



Bancone con singolo frontale

Reception counter complete with single front, Banque d'accueil avec façade simple, Theke mit Einzel-front, Complete balie met enkel front, Mostrador con unico frontal.

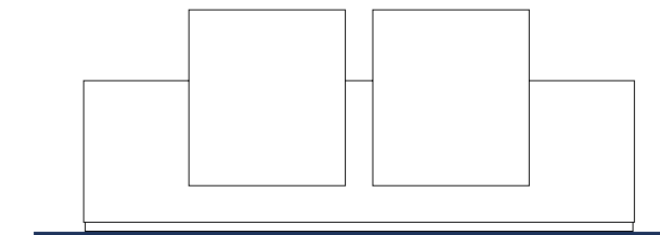

Bancone con doppio frontale

Reception counter complete with double front, Banque d'accueil avec façade double, Theke mit Doppel-front, Complete balie met dubbel front, Mostrador con doble frontal.

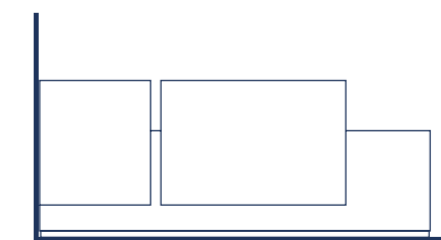

Bancone a parete

Wall side reception counter, Banque d'accueil côté mur, Theke mit Wandanschluss, Balie muurzijde, Mostrador a pared.



concerto

Integrated storage working system

**La leggerezza di un sistema modulare e personalizzabile
per un nuovo concetto dell'ambiente di lavoro.**

The lightness of a modular and flexible system designed
as a new concept for the working space.

La légèreté d'un système modulaire et personnalisable
pour un nouveau concept de l'espace du travail.

Arbeitsplätze mit Leichtigkeit durch ein flexibles
Modulsystem neu konzipieren.

La ligereza de un sistema modular y personalizable
para un nuevo concepto del ambiente de trabajo.

De eenvoud van een modulair en flexibel systeem ontworpen
voor de werkrimte.

Easily
adaptable

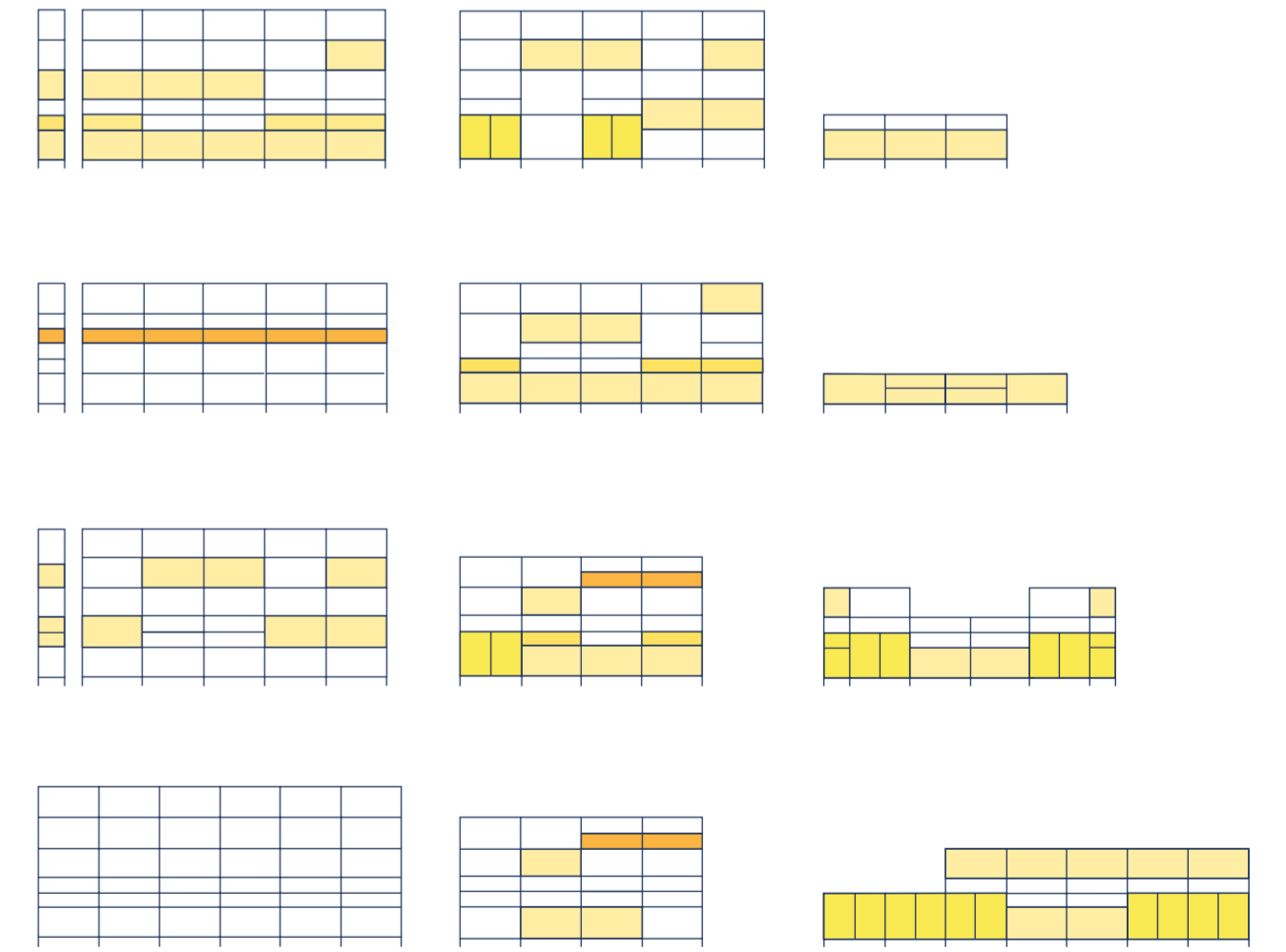

Changing style

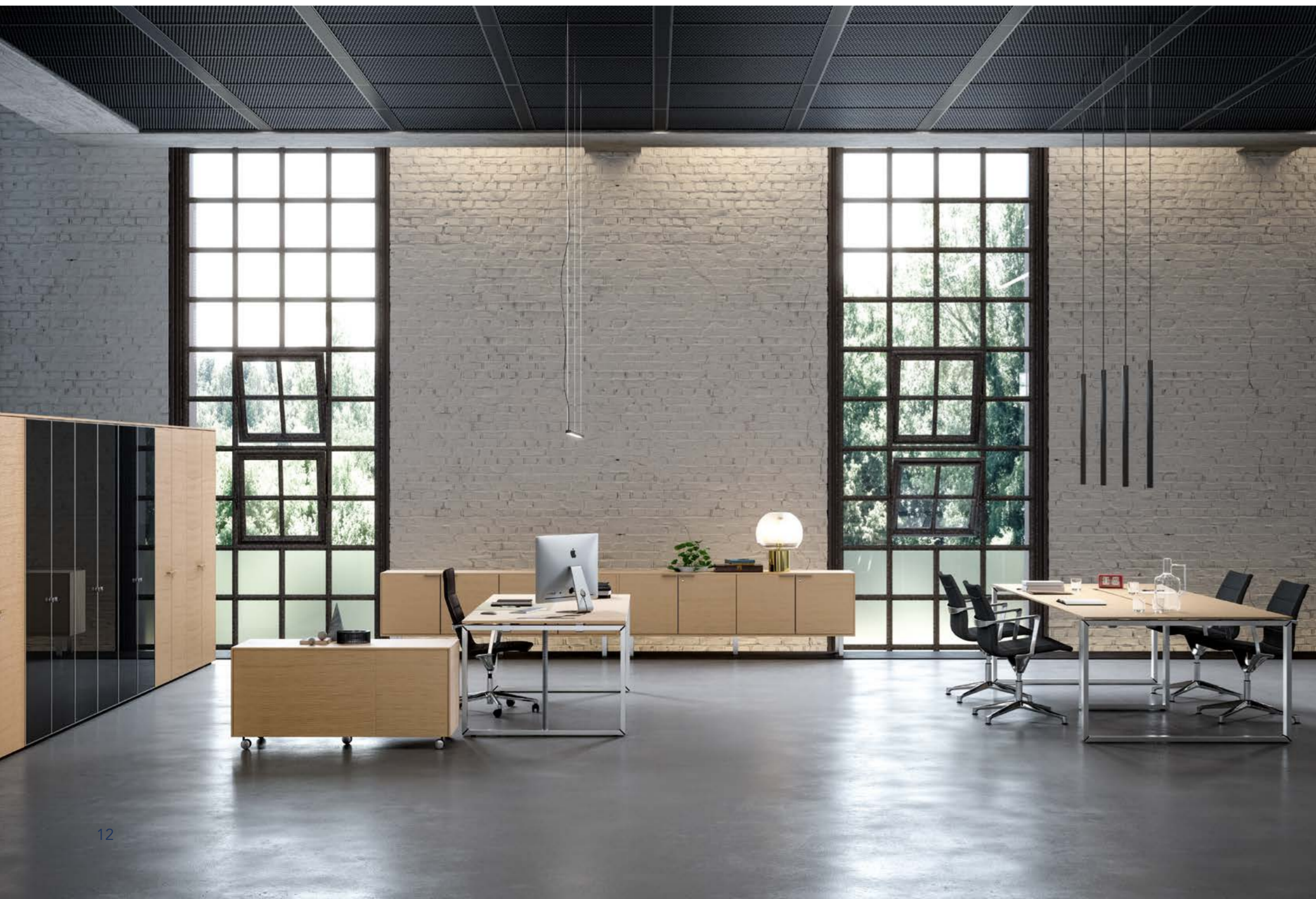

Sistema trasversale che interpreta tutti gli ambienti ufficio.

An Adaptable system that caters for all working spaces.

Système transversal qui interprète tous les ambiances de bureau.

Ein allumfassendes System sprengt herkömmliche Grenzen in Bürolandschaften.

Sistema transversal que interpreta todos los ambientes de la oficina.

Een flexibel systeem geschikt voor alle werkplekken.

For all offices



Reception

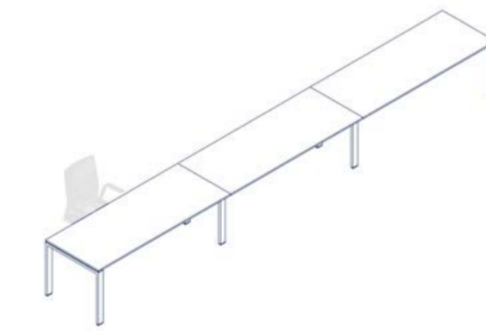

Operative

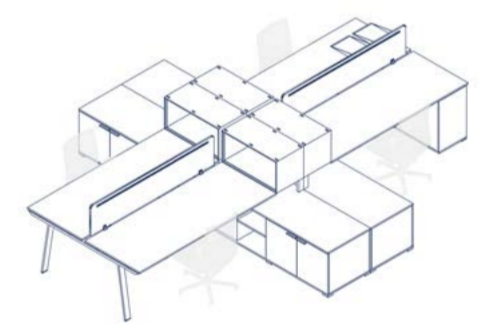

Executive

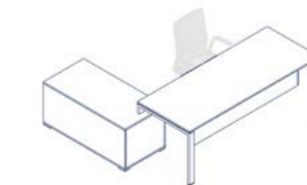

Meeting



take-off evolution

**Choose
the finish**



**Finiture tattili e materiche per uffici meno convenzionali
con soluzioni ad alta interazione.**

Tactile and alternative finishes for the more design led workstations
complete with high interactive solutions.

Finitions tactiles et matérielles pour des bureaux moins conventionnels
avec des solutions d'interaction élevées.

Material und Haptik sprengen die Grenzen konventioneller Büros
und bieten Arbeitsplatzlösungen mit hoher Integration.

Materiales que se pueden percibir las cualidades de sus acabados para
oficinas menos convencionales con soluciones para interactuar
el hombre con su medio (su puesto de trabajo).

Fraaie alternatieve afwerkingen voor meer design werkplekken
compleet met veel interactieve oplossingen.

Many finishing



evo

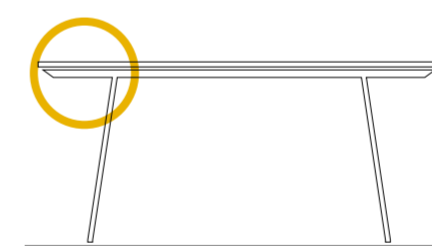

18 mm
3/4"

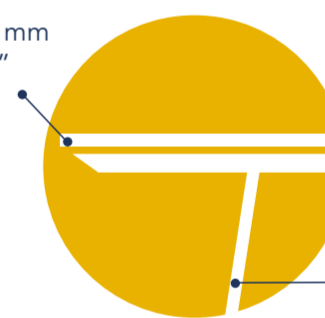

metallo
metal, métal, metall,
metaal, metal

country

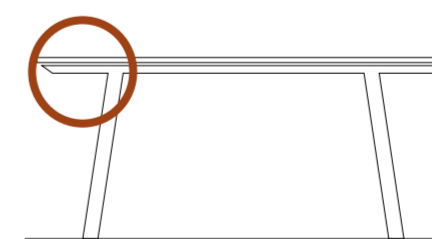

18 mm
3/4"

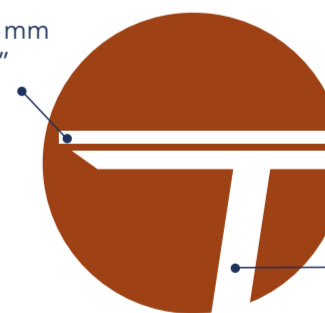

rivestito
coated, revêtu,
beschichtete, bekleed,
revestido

farm

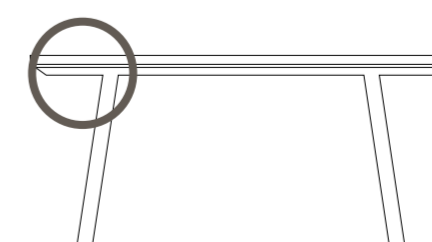

30 mm
1"

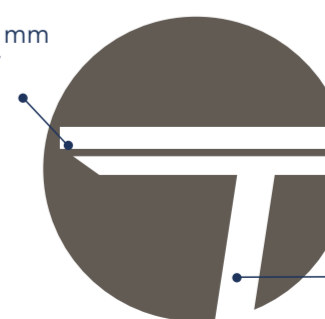

rivestito
coated, revêtu,
beschichtete,
bekleed, revestido

3° livello

**Choose
the way**



La 3^a dimensione dei posti di lavoro.

Third level storage for a variation of working spaces.

La 3^{ème} dimension de l'espace

Die dritte Dimension am Arbeitsplatz.

La 3^º dimensión de puestos de trabajo.

Variatie in de werkruimte door derde niveau afgelegimte.

Choose the height



Armadi con ante scorrevoli

Cabinets with sliding doors, Armoires avec portes coulissantes, Schranke mit Schiebetüren, Armarios con puertas correderas, Kasten met schuifdeuren

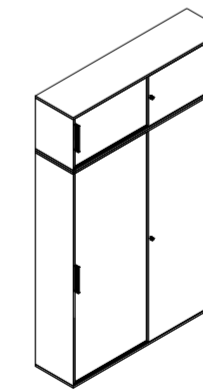

120/160x46
H.250 cm

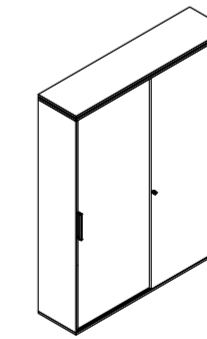

120/160x46
H.200 cm

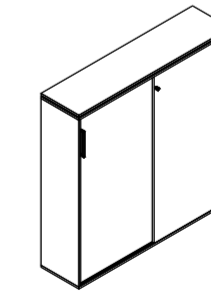

120/160x46
H.160 cm

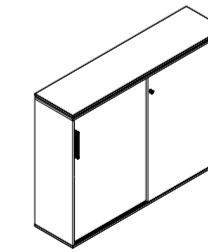

120/160x46
H.120 cm

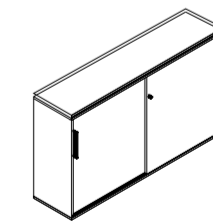

120/160x46
H.81 cm

kubick

Create your
own privacy



**Isole di lavoro nel rispetto della Privacy.
Spazi aperti ma protetti acusticamente e accessoriabili**

Individual enclosed workstations within Open spaces.
Complete with added acoustic features and accessibility.

Ilots de travail dans le respect de la confidentialité.
Espaces ouverts mais protégés acoustiquement et accessorisés.

Eine Arbeitsinsel mit Schutz des Privatbereiches.
Die Räume bleiben offen, bieten aber akustischen Schutz
und Komfort durch Accessoires.

Islas de trabajo respetando la privacidad.
Espacios abiertos pero acústicamente protegidos
y donde se pueden poner accesorios.

Individuele gesloten werkplekken in de open ruimte.
Compleet met makkelijk toepasbare akoestische elementen.

Many configurations



Sistema per il passaggio cavi e per l'elettificazione dei piani

Cables Management and electrification of the desk tops, Système pour le passage des câbles et pour l'électrification des plateaux, Kabelmanagement für Tischplatten, Kabelmanagement met transport via plinten, Sistema de paso de los cables y de electrificación de la tapa de la mesa

- 1 **Passaggio cavi elettrici attraverso lo zoccolo**
Cables Management passage through plinths, Passage des câbles électriques à travers la plinthe, Kabeldurchlass am Sockel, Kabelmanagement met transport via plinten, Cuidad en el zocalo para pasar los cables.
- 2 **Salita cavi attraverso il montante verticale**
Cables Management passage through the vertical module, Montée des câbles à travers le montant vertical, Kabelaufgang, Kabelmanagement met transport via verticale module, Subida de cables a traves del montante vertical.
- 3 **Salita cavi attraverso canale**
Cables passage through the cable duct, Goulotte pour le logement des câbles, Kabelaufgangskanal, Kabeltransport via kabeldoorvoer, Subida de cables a traves de la canal.
- 4 **Uscita cavi sul piano tramite top access**
Cables exit on the desktop via a desk top access, Sortie des câbles sur le plateau à travers le top accés, Kabelausgang mit "Top Access", Kabeldoorlaat via bovenkant bureautafel, Salida de cables a traves del acceso superior.

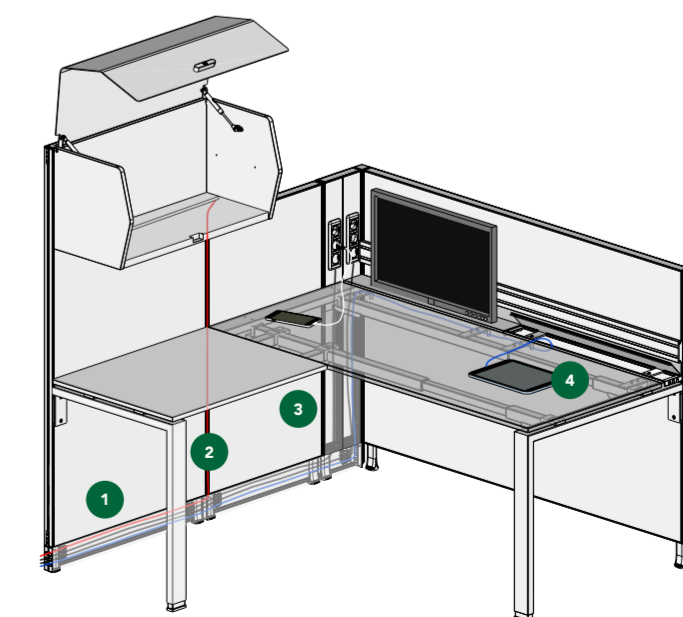

winglet

Sit stand working system



**Semplice, facile, riconfigurabile: tre misure,
una sola struttura telescopica.**

Simple, easy, adjustable: three measures,
one telescopic structure.

Simple, facile, reconfigurable: trois dimensions,
une seule structure télescopique.

Schlicht, einfach, verwandelbar: drei Größen,
ein einziges teleskopisches Gestell.

Simple, fácil, reconfigurable: tres tamaños,
una sola estructura telescópica.

Simpel, eenvoudig, verstelbaar: 3 maten,
één telescopisch onderstel.

Configure your desk



Fissa
Fixed, Fixe, Feststehend, Fija, Vas



Pulsante
Push button, Bouton poussoir, Schalter, Pulsador, Drukknop



Manovella
Crank, Manivelle, Kurbel, Manivela, Slinger



Elettrica
Electrical, Électrique, Elektrisch, Eléctrico, Elektrisch

domomag

Modular integrable



**Mobile, compatta e configurabile:
l'interpretazione della cucina integrata all'area di lavoro.**

Mobile, compact, and reconfigurable;
the interpretation of the kitchen integrated within the workspace.

Mobile, compact et configurable:
l'interprétation de la cuisine intégrée à l'espace du travail.

Mobil, kompakt, individuell zu gestalten:
eine Küchenlösung, konzipiert für die Integration in eine Bürolandschaft.

Movable, compacta y configurable:
la interpretación de la unidad de cocina para el espacio del trabajo.

Verrijdbaar, compact, herindeelbaar:
het antwoord op een pantry-keuken binnen de werkruimte.

Perfectly integrated



Composizioni su ruote

Compositions on castors, Compositions sur roulettes, Kompositionen auf Rollen, Composiciones sobre ruedas, Vrijrijdbare compositie



81x54 H.92 cm
31¾" x 21¼" H.36¼"



135x54 H.92 cm
53" x 21¼" H.36¼"

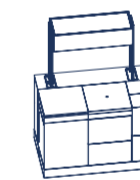
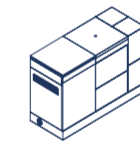
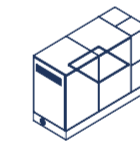

135x83,5 H.170 cm
53" x 32¾" H.67"

Moduli componibili, su piedini

Modular storage, on feet, Modules intégrés avec pieds, Einbaumodule, auf Rollen, Modulos componibles, sobre patas, Modulair opbergsysteem, op voetjes



27x54 H.92 cm
10¾" x 21¼" H.36¼"



54x54 H.92 cm
21" x 21¼" H.36¼"



27x54 H.106 cm
21¼" x 21¼" H.41¾"

Scaffale e pensili

Shelf and wall unit, Étagère et meuble suspendu, Regal und Wandmodul, Estantería y armario de pared, Plank met opknoping

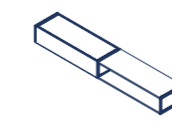

202x36 H.23 cm
79½" x 14" H.9"

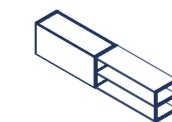

202x36 H.44 cm
79½" x 14" H.17¼"

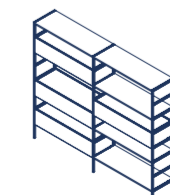

202x36 H.170 cm
79½" x 14" H.67"

rail

Shape of elegance



Linee pure ed essenziali di un'assoluta eleganza formale.

Pure and essential lines for an absolute formal elegance.
Lignes pures et essentielles d'élégance formelle absolue.

Schlichte, schnörkellose Linienführung, Edle Eleganz.
Líneas puras y esenciales de una elegancia formal absoluta.
Pure en essentiële lijnen voor absolute formele elegantie.

Essential design



Managerial

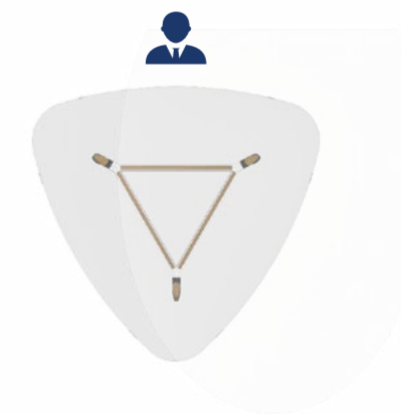

Managerial x3

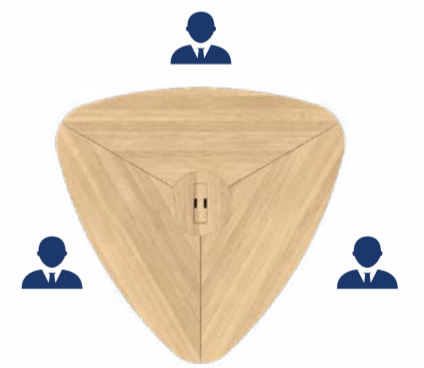

Managerial 1+1

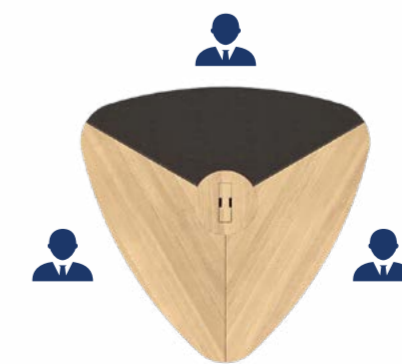

Managerial x6

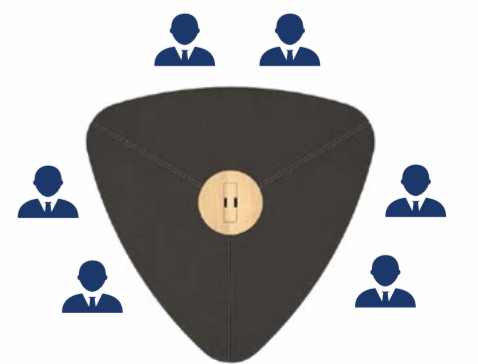

finiture

laccato opaco,

matt lacquered, lacqué matt, lacqué mat, matt lackiert, matgelakt, laqueado mate

LN nero black noir schwarz zwart negro	L4 titanio titanium titane titan titanium titanio	L2 tortora turtledove tourterelle turteltaube tortelduif törtola	L3 nebbia mist brouillard nebelgrau mist niebla	LA alluminio aluminium aluminium aluminium aluminium aluminio	LB bianco white blanc weiß wit blanco	LE deep teal deep teal bleu canard deep teal deep teal deep teal	L5 oceano ocean océan meerblau ocean oceano	L6 verde muschio moss green vert mousse moosgrün mosgroen verde musgo

LF verde natura grass green vert nature grasgrün groene natuur verde naturaleza	LR bordeaux bordeaux bordeaux bordeaux bordeaux	LJ giallo gold yellow gold jaune or goldgelb geelgouden oro amarillo

vetroceramica,

glass ceramic, vitroceramica, glaskeramik, vitrokeramisch, vitroceramica

EK nero marquina opaco marquina black matt noir mat marquina schwarz matt marquina zwart marquina mat marquina negro mate	EB bianco calacatta lucido bianc brillant calacatta weiß glänzend calacatta glanzend wit calacatta calacatta blanco brillo	EG grigio stone opaco stone grey matt gris mat stone grau matt stone grijs stone mat gris mate stone	MN nero opaco black matt noir mat schwarz matt zwart mat negro mate	MG grigio grey gris grau grijs gris	MB bianco opaco white matt blanc mat weiss matt wit mat brillo mate

metacrilato,

methacrylate, méthacrylate, methacrylat, methacrylaat, metacrilato

parti metalliche,

metal structure, structure metallique, metalstruktur, stalen constructie, estructura metálicas

NF nero black noir Schwarz zwart negro	FG metallo crudo raw metal métal brut rohes metall onbehandeld metaal metal tosco	GF grigio granito granite grey gris granit granitgrau granietgrijs gris granito	TF tortora turtledove tourterelle turteltaube tortelduif törtola	AF epox alluminio silver epoxy epoxy aluminium aluminium aluminiumkler geepoxerd epoxidica de aluminio	BW bianco white blanc weiß wit blanco

Fenix,

Fenix, Fenix, Fenix, Fenix, Fenix

HG titanio 724 titanium 724 titane 724 titan 724 titanium 724 titanio 724	HA acciaio hamilton hamilton steel acier hamilton hamilton stahl hamilton staal acero hamilton	HO bianco white blanc weiß wit blanco	NE particolari colore nero black-painted particular items détails en noir details farbe schwarz details in zwarte kleur detalles de color negro	AP particolari colore alluminio silver-painted particular items détails en aluminium details farbe aluminium details in aluminium kleur detalles de color aluminio	BP particolari colore bianco white-painted particular items détails en blanc details farbe weiß details in wit kleur detalles de color blanco

vetro temperato,

tempered glass, verre trempé, temperiertes glas, gehard glas, vidrio templado

CN nero black noir schwarz zwart negro	CU titanio titanium titane Titan titanium titanio	VG grigio sp. 5mm grey sp. 5 mm gris sp. 5 mm Grau sp. 5 mm grijs sp. 5 mm gris sp. 5 mm	CO tortora turtledove tourterelle Turteltaube tortelduif törtola	CH nebbia mist brouillard Nebelgrau mist niebla	CT satinato frosted satiné mattier gesatineers satinado	CK trasparente transparent transparent transparentes transparente transparente	CB bianco white blanc Weiß wit blanco

vetro temperato opaco,

tempered matt glass, verre tempe opaque, Matt temperiertes Glas, mat gehard glas, vidrio templado mate

SU titanio titanium titane titan titanium titanio	SN nero black noir schwarz zwart negro	SO tortora turtledove tourterelle turteltaube tortelduif törtola	SH nebbia mist brouillard nebelgrau mist niebla	SB bianco white blanc weiß wit blanco

tessuto,

fabric, tissu, stoffe, stof, tejido

P1 PUMA nero black noir schwarz zwart negro	PG PUMA grigio scuro dark grey gris foncé dunkelgrau gewoon grijs gris hormigón	P2 PUMA grigio medio medium grey gris moyen mittelgrau gewoon grijs gris hormigón	P8 PUMA blu dark blue bleu blau blauw azul	P4 PUMA bordeaux bordeaux bordeaux bordeaux bordeaux	PV PUMA verde mela apple green vert pomme apfelgrün appelgroen verde manzana	A6 CAMIRA-LUCIA testa di moro-sombrero dark brown-sombrero brun gris-sombrero donkerbruin-sombrero pardo grisáceo-sombrero	A5 CAMIRA-LUCIA petrolio-windjammer petroleum-windjammer pétrole-windjammer petroleum-windjammer petróleo-windjammer	A4 CAMIRA-LUCIA blu-martinique blue-martinique bleu-martinique blauw-martinique azul-martinique
A3 CAMIRA-LUCIA celeste-arecibo light blue-arecibo bleu-arecibo hellblau-arecibo hemelsblau-arecibo azul celeste-arecibo	A2 CAMIRA-LUCIA mattone-jamaica brick-coloured jamaica brique-jamaica ziegelrot-jamaica baksteen-jamaica pardo cobre-jamaica	A1 CAMIRA-LUCIA sabbia-aruba sable-aruba sable-aruba sandfarbe zand-aruba arena-aruba	Y6 GABRIEL-STAY grigio Londra London grey gris Londres London grau London-grijs gris Londres	Y5 GABRIEL-STAY blu avio air force blue bleu aviation avio blauw azul colombino	Y4 GABRIEL-STAY celeste light blue bleu hellblau hemelsblauw azul celeste	Y2 GABRIEL-STAY arancio orange orange orange orange naranja	Y3 GABRIEL-STAY verde green vert grün groen verde	Y1 GABRIEL-STAY giallo yellow jaune gelb geel amarillo
X2 GABRIEL-XPRESS verde sottobosco underwood green vert sous-bois unterholz-groen bosgrond-groen verdes-sottoboscoque	X3 GABRIEL-XPRESS blue jeans blue jeans blue jeans denim blue jeans blauw azul denim	X1 GABRIEL-XPRESS giallo primavera spring yellow jaune printemps frühling gelb lentegel amarillo primavera						

melaminico,

melamine, mélamine, melamin, melamine, melamina

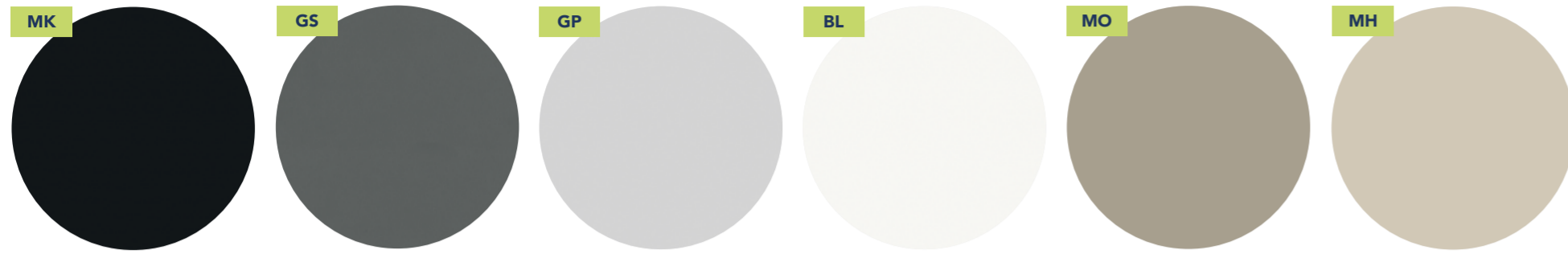

nero
black, noir, Schwarz, zwart, negro

Grigio granito
Granite grey, Gris granit, Granitgrau, Granietgrijs, Gris granito

grigio perla
pearl grey, gris perle, perlgrau, parelgrijs, gris perla

bianco
white, blanc, Weiß, wit, bianco

tortora
turtledove, tourterelle, Turteltaube, tortelduif, tórtola

nebbia
mist, brouillard, Nebelgrau, mist, niebla



wengè
wengè, wengè, Wengé, wengè, wengè

noce canaletto
canaletto walnut, noyer canaletto, Canaletto nussbaum, notenhout canaletto, nogal canaletto

rovere naturale
natural oak, chêne naturel, Nature eiche, eikenhout natuur, roble natural



rovere anticato
traditional oak, chêne antique, Eiche antik, oud eiken decormelamine, melamina roble antiguo

Acero champagne
Champagne hard maple, Érable champagne, Champagner-ahorn, Edoorn champagne, Arce champán

Legno,

wood, bois, holz, hout, madera

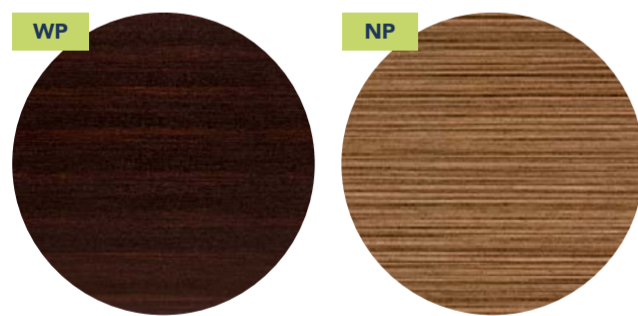

Wengè
Wengé, Wengé, Wengé, Wengé, Wengé

Noce americano
American walnut, Noyer américain, Amerikanischer Nussbaum, Amerikaans notenhout, Nogal americano

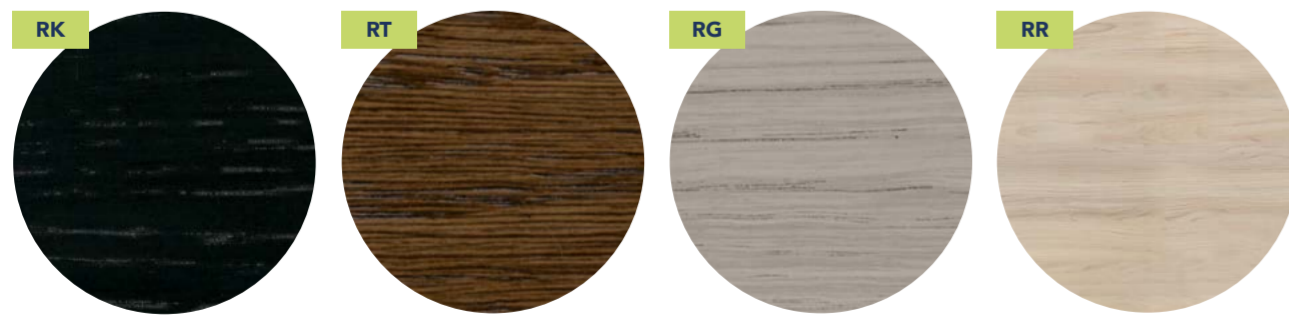

Rovere laccato nero
Black lacquered oak, Chêne laqué noir, Schwarz lackierter Eiche, Zwart gelakt eiken, Roble lacado negro

Rovere tabacco
Tobacco oak, Chêne tabac, Eiche Tabak, Eikenhout tabak, Roble tabaco

Rovere grigio
Grey oak, Chêne gris, Eiche grau, Grijs eiken, Roble gris

Rovere naturale
Natural oak, Chêne naturel, Natur Eiche, Eikenhout natuur, Roble natural



Rovere laccato bianco
White lacquered oak, Chêne laqué blanc, Weiß lackierter Eiche, Wit gelakt eiken, Roble lacado blanco



EXPERIENCE

Two generations, over 25 years of experience in production with an extensive selection of raw materials



INDUSTRIAL PRODUCTION ABILITY



SELECTION OF RAW MATERIALS

Attention and care in the selection of materials: Wood veneer / glass / leather / fabric / vitro ceramic / Fenix



WARRANTY AND AVAILABILITY OF COMPONENTS:



SPECIAL ITEMS



CERTIFIED PRODUCTION, GREEN ENVIRONMENTALLY AND USER FRIENDLY



PLANNINGS

OUR PRODUCTION SYSTEM FOLLOWS ADVANCED STANDARDS FOR INDIVIDUAL AND NATURE CARE

Our Company operates with the primary objective of guaranteeing products that achieve a correct balance between environmental sustainability and design.



CAM: CRITERI AMBIENTALI MINIMI



Vengono introdotti con l'allegato n. 2 al D.M. dell'11 gennaio 2017 e sono parte integrante del piano d'azione per la sostenibilità ambientale dei consumi della pubblica amministrazione (green public procurement). Le stazioni pubbliche appaltanti sono tenute, pena la nullità, ad introdurre nei documenti di gara «per la fornitura e il servizio di noleggio di arredi per interni» le specifiche tecniche e la clausole contrattuali definite nel documento «criteri ambientali minimi»



Imballi costituiti da materiali facilmente separabili e riciclabili



Riduzione di formaldeide e di sostanze tossiche e potenzialmente dannose



Estensione del ciclo di vita dei prodotti



Produzione di arredi a ridotto impatto ambientale



Facilità di disassemblaggio per favorire la riconfigurabilità, il riutilizzo o il riciclo

BRALCO
YOUR SMART ITALIAN OFFICE

Bralco - Via Luigi Einaudi 1, 31058 Susegana TV - Italy
T +39 0438 437 711 - F +39 0438 437 730
info@bralco.it - www.bralco.it

